

FIRE&TEK® SMOKE ALARM 755RLPSMA4

220-240 V a.c. Mains Power Photoelectric Smoke Alarm with Rechargeable Battery Backup



by Schneider Electric

PLEASE LEAVE THESE INSTRUCTIONS WITH THE OCCUPANT, TO BE RETAINED FOR THE LIFE OF THE ALARM.
THIS SMOKE ALARM MUST BE INSTALLED BY A LICENSED ELECTRICIAN.

Read all Instructions before Installation and Operation

Regular testing of this smoke alarm is necessary to ensure the unit is functional and that the battery is in good condition. It is recommended that the smoke alarm be replaced after 10 years of normal service. DO NOT try to open or repair the smoke alarm yourself. There are no user-serviceable parts inside.

Specifications

Main Power Source:	220-240 V a.c., 50 Hz
Secondary Power Source:	Rechargeable lithium battery
Operating Current:	≤40 mA
Battery Life:	Ten years
Sensing Type:	Photoelectric. This alarm contains NO radioactive material
Operating Temperature:	0 °C to 45 °C
Ambient Humidity:	5% to 95%
Interconnecting:	40 alarms over 150 metres maximum (20 alarms for wireless)

Terminal Provisions:	Active, Neutral, Loop and Interconnect terminals, each accommodates 2 × 1.5 mm ²
Horn Level:	85 dB at three metres minimum
Visual Indicators:	Green LED for mains power ON Red LED for warning and low battery indication
Alarm Condition:	Aural signal pattern (ISO 8201)
Approvals:	Activfire SAI Global RCM
Complies with:	AS3786: 2014 AS/NZS 60065 and AS/NZS 60950.1

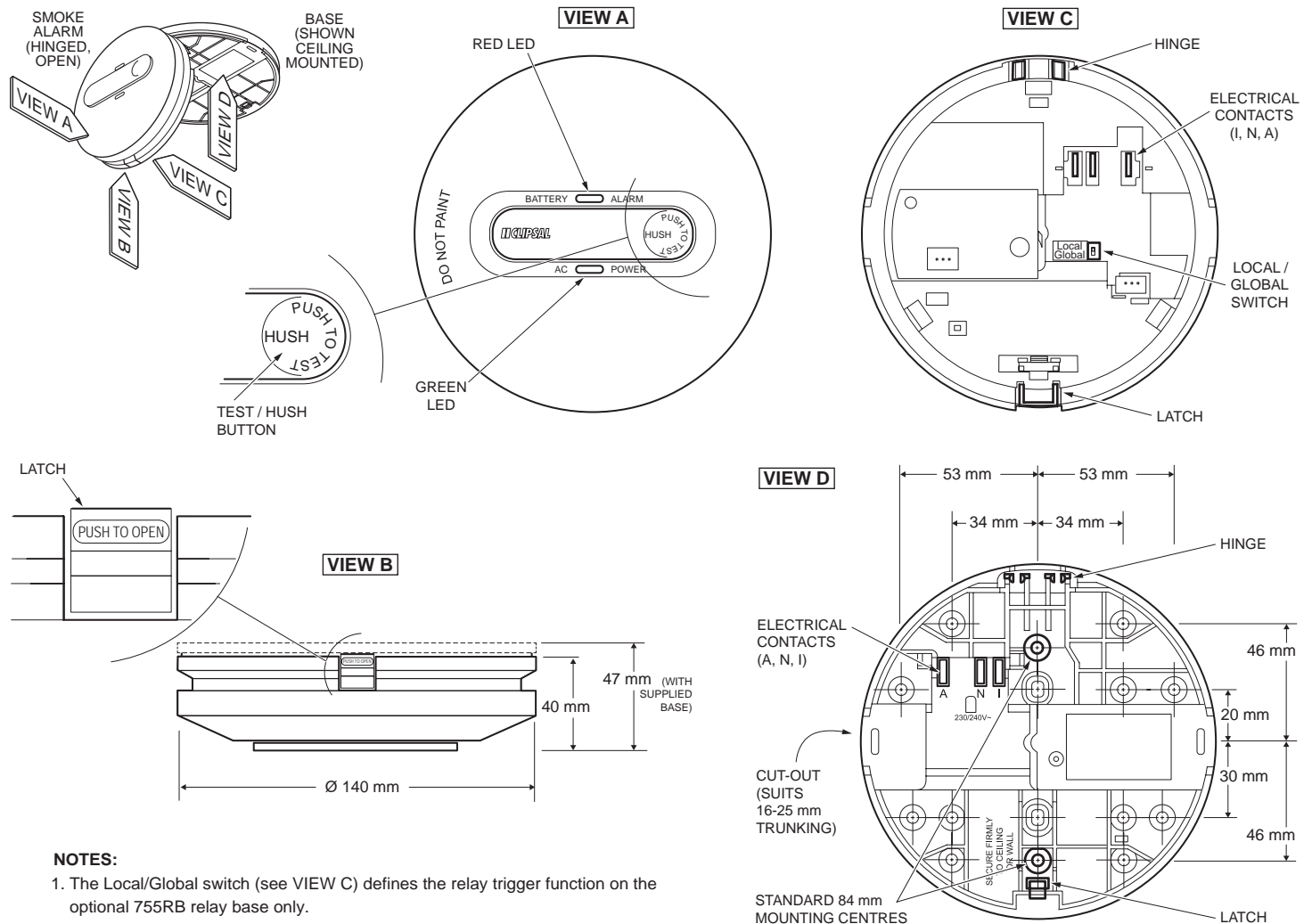

NOTES:

1. The Local/Global switch (see VIEW C) defines the relay trigger function on the optional 755RB relay base only.

Hush or Silence Feature

- This smoke alarm has a built-in Hush or Silence feature incorporated into the Test button (see VIEW A in the diagram above).
- If cooking or other non-hazardous sources cause the alarm to sound, it can be temporarily silenced by pressing the Test / Hush button for three seconds.
- The alarm then enters a dormant period for 10 minutes.
- If the smoke density increases during this period from a smoke or fire event, the unit will go into alarm mode.
- After the 10 minute dormant period, the smoke alarm will resume normal operation.

Recommended Location of Alarms

- Locate the first alarm in the immediate areas of the bedrooms. Try to protect the exit path as the bedrooms are usually furthest from an exit. If more than one sleeping area exists, locate additional alarms in each sleeping area.
- Locate additional alarms to protect any stairway as stairways act like chimneys for smoke and heat.
- Locate at least one alarm on every floor level.
- Locate an alarm in any area where a smoker sleeps or where electrical appliances are operated in sleeping areas.
- Smoke, heat and other combustion products rise to the ceiling and spread horizontally. Mounting the detector on the ceiling in the centre of the room places it closest to all points in the room. Ceiling mounting is preferred in ordinary residential construction. However, in mobile homes, wall mounting on an inside partition is required to avoid the thermal barrier that may form at the ceiling.
- When mounting the alarm onto a ceiling, locate it a minimum of 30 cm from a side wall and 30 cm from any corner (see Diagram A).
- When mounting the alarm on a wall, use an inside wall with the alarm a maximum of 50 cm below the ceiling and at least 30 cm from any corner (see Diagram A).

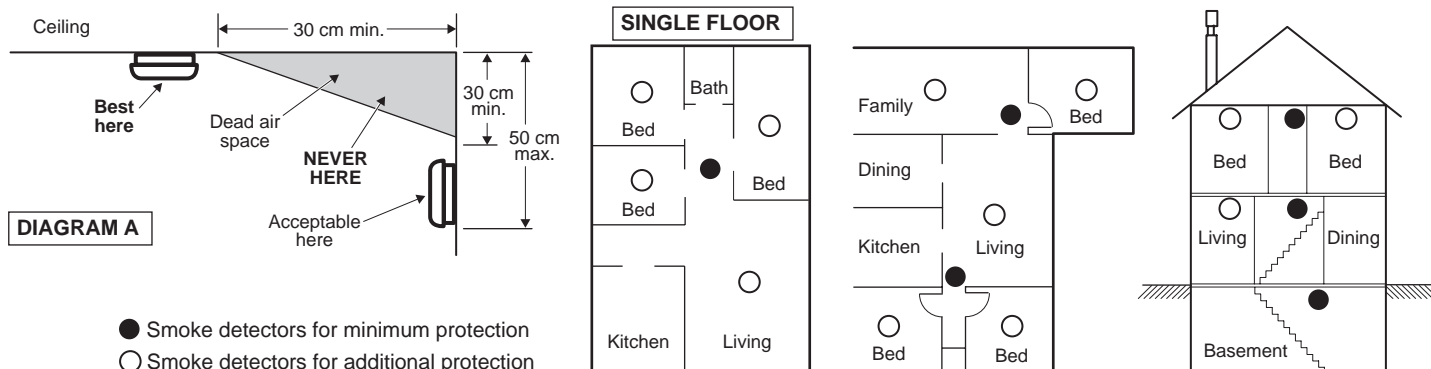

AVOID THESE LOCATIONS

- Do not install a smoke alarm within one metre of heating and cooling supply vents or within one metre of return air or fresh air vents. Smoke may be blown away from the smoke alarm by the supply vents, or could be diffused or reduced by being diverted into the return air vent.
- Do not install your smoke alarm in an area where the temperature may fall below 0 °C or rise above 45 °C. Smoke alarms are designed to operate only within these temperature ranges and failure to alarm, improper alarms or nuisance alarms may result from operation outside these temperature limits.
- Do not install a smoke alarm in a damp or very humid area such as bathrooms with showers, where the normal humidity may rise above 95%. Above this level, moisture may condense inside the smoke chamber and cause false alarms. The smoke alarm may also become unstable below 5% relative humidity.
- Do not install a smoke alarm in an area where particles of combustion are normally present, such as garages or kitchens, etc. as this can cause false alarms.
- Do not install a smoke alarm in dusty or dirty areas – such an installation cannot be relied on. An accumulation of dust and dirt in the sensing chamber may block the openings and prevent an alarm, or may get inside the alarm and cause false alarms. If a smoke alarm is required in such an area, vacuum it frequently and test it according to the 'Operation and Testing' section of this leaflet.
- Do not install a smoke alarm in the dead air space in the corner where the wall meets the ceiling. For your safety, if you are unsure of the best location for mounting the smoke alarm, contact your local fire department for advice.
- Do not install a smoke alarm where bugs or insects are present before eliminating or minimising the problem. If bugs are present, vacuum the unit frequently as described in 'Maintenance, Repairs and Service' on page 4 of this document.
- Do not install a smoke alarm within one metre of electrical noise sources, e.g. fluorescent lights, LED lights and fan motors. Electrical noise may cause nuisance alarms.

Interconnecting Smoke Alarms

HOW INTERCONNECTED ALARMS FUNCTION

- Interconnecting smoke alarms is a method of joining a series of alarms so that if any one alarm senses smoke, all the connected alarms will operate (alarm).
- A 9 V signal is applied to the interconnect wire (referenced to neutral) to alarm all the other interconnected alarms.
- An optional wireless base (Catalogue No. 755RFB) may be purchased separately if wired interconnection is not possible.

CAUTION

RISK OF INJURY AND EQUIPMENT DAMAGE / MALFUNCTION

- All interconnected smoke alarms must be supplied from the same circuit.
- A common Neutral must be used for the Interconnect to function.
- DO NOT connect the Interconnect wire to Active or Neutral.
- A maximum of 40 Clipsal 755 smoke alarms can be installed on one circuit (wired interconnection only).
- Only Clipsal smoke alarms can be interconnected with each other.

Failure to follow these instructions may result in injury and equipment damage / malfunction.

TERMINAL

- A:** Active / Line
- E-LOOP:** Earth or Loop
- N:** Neutral
- I-Connect:** Interconnect

Max. Interconnected Alarms: 40
Max. wiring length between first and last alarm: 150 m

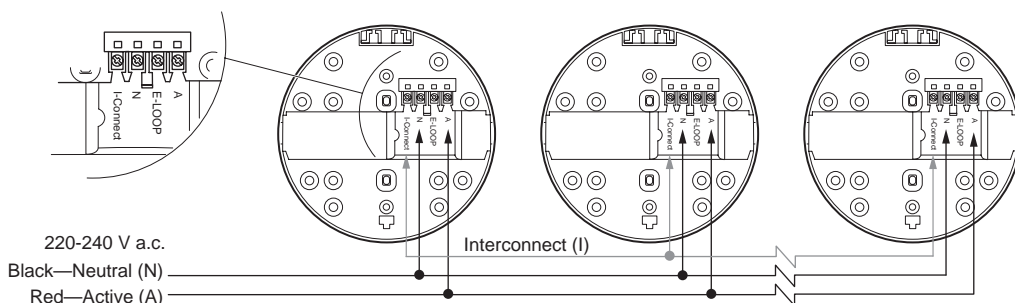

Installation

⚠️ ⚠️ DANGER

HAZARD OF ELECTRIC SHOCK, EXPLOSION, OR ARC FLASH

- It is illegal for persons other than appropriately licensed electricians or other persons authorised by legislation to work on the fixed wiring of any electrical installation.
 - This product must be used only for the purpose described in this instruction and must be installed in accordance with the wiring rules and regulation in the location where it is installed.
 - Hazardous voltage may be present at the wire leads of this product.
 - Lock out and tag the input circuit before accessing the wiring connections.
- Failure to follow these instructions will result in death or serious injury.**

⚠️ CAUTION

EQUIPMENT INSTALLATION HAZARD

1. Make sure Live and Neutral of mains be wired to correct terminals.
 2. Make sure Green LED is ON when mains power is supplied.
 3. Test each interconnected unit one by one, press and hold Test button until the second burst of 3 beeps has finished, check to ensure every interconnected unit alarms correctly.
If any unit failed to alarm, check all wiring and connections carefully.
- Failure to follow these instructions may result in equipment damage.**

NOTE: The smoke alarm will function correctly either as a stand-alone alarm or interconnected. All interconnected smoke alarms must be supplied from a single power circuit. A common Neutral must be used for the Interconnect to function. Do not connect the Interconnect wire to Active or Neutral.

Use a minimum of 1.0 mm² 250 V insulated wire for all wiring, including interconnecting wiring.

1. Strip the Active, Neutral and Interconnect (if used) wires back to the strip length shown in (A) in the diagram to the right.
2. Connect the wires to the correct terminals on the base (see (B) in the diagram to the right) and ensure the terminal screws are fully tightened.
3. Clip the terminal cover closed to avoid contact with the live terminals. See (C) in the diagram to the right.
4. Screw the mounting base onto the ceiling or wall using appropriate fasteners.
5. Clip the smoke alarm on to the base and remove the transport disconnect interlock (see section 'Installing / Removing the Transport Disconnect Interlock' below). The smoke alarm base will only close with the transport disconnect interlock removed.

Note: Do not attempt to close the base unless the transport disconnect interlock is removed.

6. Turn on the mains power and check that the green and red LEDs function. The Green LED should illuminate to show mains power present. The Red LED will pulse every 40-60 seconds to indicate correct operation and that the backup battery is okay.
7. Press the Test / Hush button to check the alarm works.

Installation is not complete until both LEDs are functioning correctly and the alarm has been checked for correct operation.

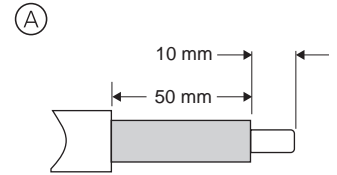

220-240 V a.c.
Cable min. 1.0 mm²

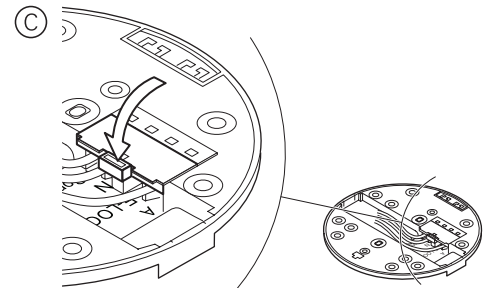
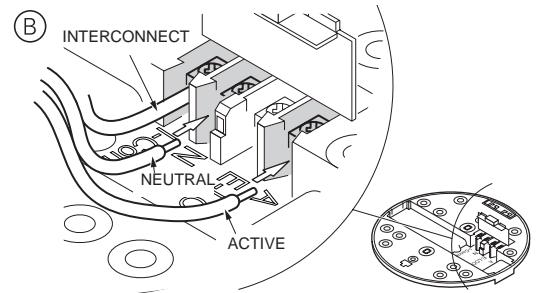

Operation and Testing

OPERATION	TESTING
<p>Operation Once the mains power (220–240 V a.c.) is connected and the transport disconnect interlock has been removed, the smoke alarm is operating.</p> <p>Operation Once Smoke Is Detected The smoke alarm will sound a loud alarm (85 dB) and the red LED will flash rapidly. This will continue until the air is cleared.</p> <p>Standby Condition The red LED flashes once every 40-60 seconds to indicate the smoke alarm and battery are functioning correctly.</p> <p>Green LED The green LED is illuminated when the mains power (220-240 V a.c.) is on.</p>	<p>TEST THE SMOKE ALARM ONCE PER MONTH TO ENSURE PROPER OPERATION Test by pushing the Test / Hush button on the smoke alarm for three seconds until the alarm sounds. The alarm will sound if all electronic circuitry, horn and battery are working. If no alarm sounds, check that the transport disconnect interlock is removed. If the transport disconnect interlock is removed and the alarm still doesn't sound, replace the smoke alarm.</p> <p>If the smoke alarm is installed in a mobile home, test weekly and after every journey.</p> <p>IMPORTANT: If premises are unoccupied for a period of time (more than a few days) then a battery test should be undertaken upon return. If the low battery warning sounds, connect mains power (220-240 V a.c.) to the premises or mobile home and allow the built-in battery to recharge.</p> <ul style="list-style-type: none"> • Never use an open flame of any type to test your alarm. • Check that all interconnected smoke alarms operate during the test.

Important information: After the Test / Hush button has been pressed, wait 10 minutes before any additional testing is conducted to avoid any false alarm responses as product has reduced sensitivity during this period. Refer to 'Hush or Silence Feature' on page 1 of this document.

Installing / Removing the Transport Disconnect Interlock

The secondary backup power for the smoke alarm is supplied by a non-removable rechargeable lithium battery. The battery is sealed in the smoke alarm and cannot be replaced.

You can isolate the backup battery to move or store a smoke alarm by installing the transport disconnect interlock. (See the diagram to the right.)

Important: Ensure that the transport disconnect interlock is removed when the smoke alarm is installed. See Step 5 in the section 'Installation'.

IT IS RECOMMENDED TO REPLACE THE SMOKE ALARM UNIT AFTER 10 YEARS.

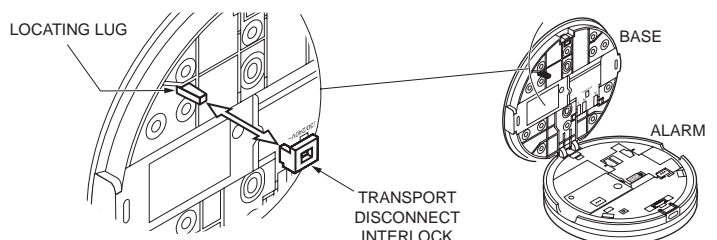

Operations and Troubleshooting

CONDITION	MEANING	RESOLUTION / ACTION
Alarm sounds and the red LED is blinking rapidly.	Smoke has activated the smoke alarm.	Vacate the building and call the fire brigade. (Refer to the Smoke Alarm General Information leaflet.)
Green LED ON.	220-240 V a.c. mains power ON.	Normal operating condition.
Green LED OFF. Mains power may be disconnected.	220-240 V a.c. mains power OFF.	Check mains power ON. Main circuit breaker may have tripped. Wiring could be reversed.
Red LED flashes every 40 to 60 seconds.	The smoke alarm is functioning correctly.	Normal operating condition.
Red LED not flashing.	Backup battery disconnected.	Remove the transport disconnect interlock.
Audible Beep is heard once every minute.	Low battery indicator is warning.	Test and check the main power connection.
When Test / Hush button is pressed for three seconds alarm sounds briefly.	The smoke alarm horn is indicating that all electronic circuitry, horn and battery are working.	Normal test condition. Test regularly to ensure proper operation.
When Test / Hush button is pressed for three seconds alarm does not sound.	Smoke alarm may not be operating correctly.	Check that the green LED is on and that the red LED flashes every 40 to 60 seconds. If the green LED is on and the red LED is flashing every 40 to 60 seconds, then contact an electrician as the smoke alarm may not be operating correctly.
Smoke alarm is sounding, you press the Test / Hush button and it stops.	Hush feature has been activated for 10 minutes providing the smoke density does not increase.	Normal condition. Clear the smoke if safe to do so.
Smoke alarm is sounding and you press the Test / Hush button but nothing happens.	Smoke density is too high for the Hush feature to activate.	Vacate the building and call the fire brigade. (Refer to the Smoke Alarm General Information leaflet.)
Smoke alarm body will not close on the base.	Transport disconnect interlock is still located in the base.	Remove the transport disconnect interlock.
Red LED is off and alarm is sounding.	Smoke has activated an interconnected alarm, located somewhere else in the building.	Vacate the building and call the fire brigade. In the event of a false alarm (use caution), locate the source of the alarm. This unit will have its alarm sounding and red LED blinking rapidly.
Red LED flashes very quickly (3 times per second) without sounds.	Neutral connection is bad, or wrong wiring.	Check wiring and connection of units with flashing Red LED carefully and rectify wiring issue immediately.

Maintenance, Repairs and Service

Maintenance: It is recommended that the smoke alarm is inspected monthly to ensure it is free from dirt, dust and insects. The alarm can be vacuumed or brushed with a soft brush to remove dust, dirt or kitchen grease that has accumulated. A small amount of surface spray around the alarm should deter insect ingress.

ALWAYS TEST THE SMOKE ALARM AFTER CLEANING.

Repairs / Service: If the smoke alarm is defective in any way, do not tamper with the unit. The unit does not contain any user-serviceable parts.

Disposal: As the alarm does not contain any radioactive material, disposal with normal rubbish is permitted in Australia and New Zealand.

Warranty Statement

Schneider Electric (Australia) Pty Ltd, (Clipsal by Schneider Electric), warrants this product to be free from defects in materials and workmanship for a period of five years from the date of installation. The benefits conferred herein are in addition to any other rights and remedies you may have at law in respect to this product. Australian and New Zealand customers please see the notes below.

Australia: Australian Consumer Law specifies that our goods come with guarantees that cannot be excluded. You are entitled to a replacement or refund for a major failure and compensation for any other reasonably foreseeable loss or damage. You are also entitled to have the goods repaired or replaced if the goods fail to be of acceptable quality and the failure does not amount to a major failure.

New Zealand: This guarantee is in addition to and does not affect your rights under applicable law, except where that law expressly provides otherwise. The Consumer Guarantee Act 1993(NZ) will not apply if this product is purchased for the purpose of business.

This warranty is expressly subject to the Schneider Electric product being installed, wired, tested, operated and used in accordance with our instructions and specifications. Any alterations or modifications made to the product without our permission will void the warranty. Schneider Electric will at its option repair, replace or refund any defective product. The cost of replacement or repair of a defective product is limited to the price of the product only. Schneider Electric will not be responsible for the cost of retrieving, removing, reinstalling, transporting (including return of the defective product to us) or re-testing a product.

How to make a claim: You shall provide Schneider Electric with adequate particulars of the defect within 28 days of the fault occurring. Contact your local Schneider Electric, PDL or Clipsal products' supplier and provide the details of the date of purchase, description of load or connections and the circumstances of the failure. Returned products must be securely packed and labeled for proper processing.

CLIPSAL[®]

by Schneider Electric

Australia
Schneider Electric (Australia) Pty Ltd
 Customer Care Australia:
 1300 369 233
 Email:
 customercare.au@schneider-electric.com
 www.schneider-electric.com.au

Technical and Sales Support

For assistance with technical problems, contact your nearest Schneider Electric sales representative.

New Zealand
Schneider Electric (NZ) Ltd
 38 Business Parade South, Highbrook,
 East Tamaki, Manukau 2013
 P.O. Box 259370 Botany, Manukau 2163
 Telephone +64 9-829 0490, Fax +64 9-829 0491
 After hours service hotline:
 0800 735 4357 (New Zealand only)
 Customer Care: 0800 652 999
 Email:
 sales@nz.schneider-electric.com
 www.schneider-electric.com

Schneider Electric reserves the right to change specifications, modify designs and discontinue items without incurring obligation and whilst every effort is made to ensure that descriptions, specifications and other information in this catalogue are correct, no warranty is given in respect thereof and the company shall not be liable for any error therein.

© Schneider Electric 2017

This material is copyright under Australian and international laws. Except as permitted under the relevant law, no part of this work may be reproduced by any process without prior written permission of and acknowledgement to Schneider Electric.

Schneider Electric acknowledges that the Australian Standard Certified Product logo is a trademark of SAI Global, and that the Activfire Certified logo is a trademark of CSIRO.

